



52020 **General
Information
Catalogue**



daymixgroup.com





ENGINEERING CONSTRUCTION CHEMICALS

ADVANCING TECHNOLOGY, STRENGTHENING INDUSTRIES, DAYMIX DIFFERENCE

DAYMIX GROUP, with over 20 years of experience, is a well-established and dynamic business community that adds value to its customers through a quality-, trust-, and innovation-oriented approach in every sector it operates.

Within our organization, DAYMIX ENGINEERING, DAYMIX CONSTRUCTION, and DAYMIX CHEMICALS provide comprehensive services and supply support across various industries – including defense and metal industries, construction, formwork and scaffolding systems, as well as metal coating and painting systems.

Since our foundation, we have aimed to maintain the highest level of customer satisfaction, achieve sustainable growth, and be a leading force in our sectors. With innovative technologies, strong supply capacity, and a team of experts, we have become a trusted business partner in Turkey, Iran, Iraq, Syria, Serbia, Albania, and Montenegro.

Without compromising our core values – honesty, transparency, innovation, and a people-oriented management approach – we continue to move confidently toward the future.

Daymix Group



DAYMIX ENGINEERING

As Daymix Engineering, with 20 years of experience and a strong background, we provide services in machining, CNC machine programming, fixture design, special machine design and manufacturing, and engineering support systems.

To maintain the highest quality standards, our company, supported by an experienced technical team, has proven its ability to develop effective solutions and deliver excellence in every application.

Remaining committed to our core principles of honesty, reliability, and integrity, we continue our work with the same dedication that has guided us since the beginning.

With the capacity to meet our valued customers' needs in the most accurate, efficient, and economical way possible, our company continues its operations confidently – maintaining the same enthusiasm and commitment as on the very first day.



DAYMIX CONSTRUCTION

Daymix Construction is a professional and innovative contracting and marketing company that provides structural and finishing construction services, while also operating in the fields of formwork, scaffolding, and construction materials.

Since our establishment, we have made it our core principle to deliver solid, aesthetic, and durable projects. From the rough construction phase to the finest project details, our experienced engineering team and skilled workforce work meticulously to ensure excellence at every stage.

By combining high-quality materials, modern techniques, and professional craftsmanship, we create a distinct difference throughout the entire construction process.

In addition, thanks to our extensive supply network within the industry, we provide our domestic and international partners with formwork, scaffolding, and construction materials at competitive prices and with fast delivery.



DAYMIX CHEMICALS

Daymix Chemicals is a specialized company offering high-quality solutions in industrial surface coatings. With its durable galvanized coatings, Daymix Chemicals ensures long-term protection of metal surfaces against environmental effects. In addition, it provides a wide range of industrial paints designed for both aesthetic and protective purposes, serving various industries such as heavy industry, automotive, construction, and manufacturing.

With a strong logistics network, R&D capabilities, and after-sales technical support, Daymix Chemicals is a reliable supplier of paint and coating chemicals for both domestic and international markets. Its product portfolio is carefully selected to meet performance, ease of use, and environmental standards, offering customers efficient and sustainable solutions.

With its industry experience and innovative approach, Daymix Chemicals is steadily advancing toward becoming one of Turkey's leading companies in industrial paints and surface protection chemicals.

MANUFACTURING ENGINEERING



As Daymix Engineering, with 20 years of experience and a strong background, we provide our clients with services in machining, CNC machine programming, fixture design, custom machine design and manufacturing, and engineering support systems.

To maintain the highest quality standards, our company—backed by an experienced technical team—has proven its ability to develop solutions for challenges and deliver excellence in all applications. We continue our work with the same precision and dedication as always, remaining committed to our principles of integrity, honesty, and reliable service.

Our company has the capability to meet the needs of our valued clients, who deserve the highest level of service, in the most accurate, efficient, and cost-effective manner. With our entire team, we continue our operations confidently, maintaining the same enthusiasm and commitment as on the very first day.

Our Services:

- Machining
- CNC Machine Programming
- Mold, Fixture, and Jig Design and Manufacturing
- Custom Machine Design and Manufacturing
- Engineering Support Systems



Machining

Machining is the process of shaping a designed metal workpiece into the desired geometric form by removing chips of various shapes and sizes from its surface in accordance with established standards. This shaping operation must be carried out using appropriate tools and machines.

Machining is not limited to a single type of process. The main machining methods can be generally categorized as turning, milling, drilling, and grinding.



Programming for CNC Machines

Daymix Engineering provides reliable CNC machine programming solutions to meet customer requirements.

Using detailed information such as readable part drawings, machine-specific specifications, raw material and dimensions, existing tool lists, and sample programs, we can support CNC lathes, horizontal machining centers, vertical machining centers, VTLs, 4- & 5-axis machines, and turn-mill centers.



Mould Fixture Tooling Design & Manufacturing

We design and manufacture moulds tailored to the needs of companies. Our company's capabilities include the following moulds: Cutting Moulds, Punching Moulds, Bending Moulds, Progressive Moulds, Transfer Moulds, Plastic Injection Moulds, Metal Injection Moulds.

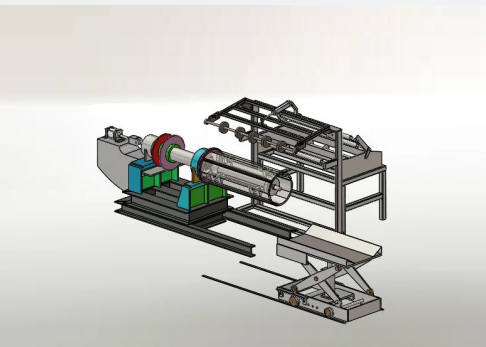

Custom Machine Design & Manufacturing

Our company has the capability to design and engineer custom machines, jigs, and fixtures according to customer requirements. We approach challenges with an engineering perspective, developing tailored solutions for each project. Based on your needs, our engineering team can implement semi- or fully-automated, state-of-the-art systems, providing effective solutions for all your custom machine requirements.



Engineering Support Systems

In the machine manufacturing sector, the shortage of skilled personnel is increasing every day. Due to the limited number of experienced employees with sufficient knowledge in design and manufacturing, and the high cost of employing trained staff, many processes in small and medium-sized enterprises as well as large corporate companies are largely left to the expertise of master craftsmen.

CONSTRUCTION

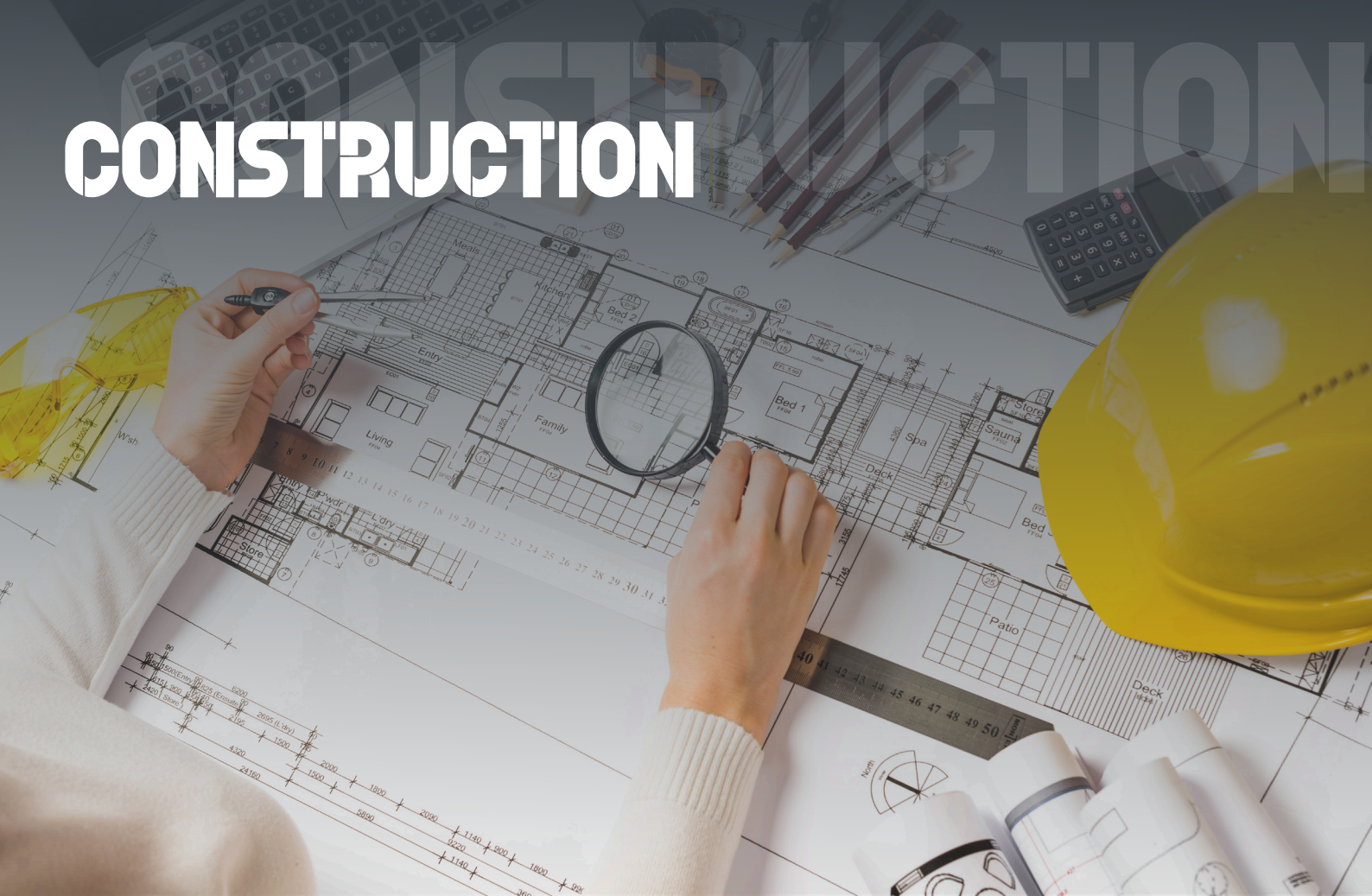

Daymix Construction is a reliable and innovative contracting company operating in structural construction, finishing works, and the sale of formwork and scaffolding materials. Since our establishment, we have made it our core principle to deliver solid, aesthetic, and long-lasting projects.

From the rough construction phase to the finest project details, our experienced engineering team and skilled workforce work meticulously to ensure excellence. At every stage, we make a difference through high-quality materials, modern techniques, and professional craftsmanship.

In addition, thanks to our extensive supply network in the industry, we provide high-quality formwork and scaffolding materials to our clients with competitive pricing and fast delivery. This way, we not only construct our own projects but also offer reliable material supply to other companies and individual customers.

On-time delivery, adherence to budget, and customer satisfaction are our unwavering principles in every project. As Daymix Construction, our mission is to be a leading brand in the construction sector, providing both high-quality structures and trusted material supply.

Our Services:

- Contracting Projects
- Formwork and Roofing
- Exterior Sound and Thermal Insulation
- Parking Construction and Marking
- Steel Construction Structures
- Landscaping and Site Development

Our Products:

- Slab Formwork Systems
- Wall and Column Formwork Systems
- Facade Scaffolding Systems
- Safety Systems
- Modular Living and Working Containers
- Plywood Products
- Lumber Products
- Wire and Nail Products

Slab Formwork Systems

During the concreting process of horizontal load-bearing systems, it offers high load capacity and dimensional accuracy. Its modular structure enables fast installation, low labor costs, and maximum efficiency. System solutions are available for beam-supported, beamless, and custom slab types.



Wall and Column Systems

These systems, designed for column and shear wall applications, feature modular structures that can withstand high concrete pressure, allowing for fast installation and a smooth concrete surface. They are suitable for repeated use and provide project-specific solutions.



Facade & Scaffolding Systems

These are external scaffolding systems that provide a safe working environment for facade operations. With their durable, modular, and standards-compliant design, they can be easily integrated into any building type. Installation is practical, and they offer maximum safety throughout their use.



Safety Systems

These are edge protection, platform, net, and barrier systems used on construction sites to prevent fall risks. They are fully compliant with occupational health and safety regulations and offer quick-to-install, durable solutions.



Modular Living & Working Containers

Modular containers designed for office, cafeteria, and dormitory needs on construction sites offer quick installation and high durability. Their portable structure, insulated comfort, and functional interior design provide practical and cost-effective solutions for temporary accommodation and workspaces.



Plywood Products

Plywood is a durable and versatile sheet material produced by pressing thin layers of wood together with special adhesives under high pressure. On construction sites, it is commonly used for formwork surfaces, flooring, and temporary structures. Its high strength, moisture resistance, and reusability provide safe and cost-effective solutions for reinforced concrete applications.



Lumber Products

Lumber is a construction material obtained from natural wood and has a wide range of applications on construction sites. It is commonly used in formwork systems, scaffolding, temporary support elements, and various structural supports. Its easy workability and strength provide practical and reliable solutions throughout construction processes.



Wire and Nail Products

Wires and nails, used as essential fastening and securing elements in construction projects, play a key role in assembling structural components, installing formwork systems, and various temporary fixings. Their durable construction ensures safe and long-lasting solutions even under challenging site conditions.





CHEMICAL



Daymix Chemicals is a solution partner operating in the paints and protective coatings sector with a strong commitment to quality, professionalism, and innovation. Leveraging our industry experience and expert team, we offer a wide range of products specifically developed to meet the needs of various industries.

Our goal is not only to supply products but to develop long-lasting, high-performance solutions that add value to our clients' projects. In every product, we prioritize durability, aesthetics, and reliability, while adopting innovative approaches that provide added value to our partners.

Industries We Serve:

- Scaffolding and formwork systems
- Steel constructions
- Machinery and equipment
- Prefabricated structures
- Pipes and profiles
- Cranes and tower crane systems
- Construction and decoration applications

With our protective coating and paint solutions in these fields, we not only protect your projects but also secure their future performance. We build strong partnerships with our clients based on transparency, sustainability, and professional values.

Scaffolding and Formwork Protective Solutions

With our protective coating solutions for scaffolding and formwork systems, we safeguard your materials against corrosion and environmental effects. Our products, which increase durability and reduce maintenance costs, ensure long-lasting efficiency in your projects.



Construction Protective Solutions

With our protective coating solutions specifically developed for steel structures, we safeguard your buildings against harsh environmental conditions. Our products provide superior protection against corrosion, moisture, chemicals, and weather effects, ensuring long-lasting durability for steel constructions.



Pipe and Profile Protective Solutions

The paints and protective coatings we offer for pipes and profiles protect your structural components from environmental effects and corrosion, ensuring long-lasting performance. Our advanced formulations not only enhance durability but also support an aesthetic appearance.



Machine Paint and Protection Solutions

We offer specially developed paint and protective coating solutions for machines and industrial equipment. Our products protect your machinery against corrosion, wear, and external factors, while extending service life and reducing maintenance needs. These durability-enhancing solutions ensure that your equipment operates safely and efficiently.



Road and Traffic Safety Coatings

The paints we develop for road and traffic safety provide maximum visibility, durability, and long-lasting performance for lines and markings. Our products offer high resistance to heavy traffic, harsh weather conditions, and wear, enhancing the safety of drivers and pedestrians.

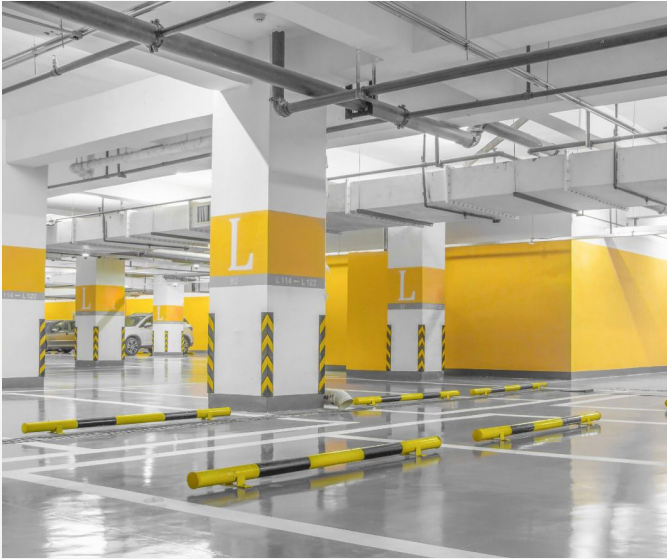

Epoxy Floor Coatings

Epoxy floor coatings combine durability, hygiene, and aesthetic appeal. They provide long-lasting protection against machine traffic in factories and production facilities, abrasive effects of transport vehicles in warehouses, chemical and liquid spills in hospitals and laboratories, vehicle traffic in parking lots and garages, and heavy foot traffic in showrooms and commercial spaces. With their easy-to-clean and attractive surface, they offer reliable solutions across all industries.



Interior and Exterior Paints

Interior and exterior paints provide long-lasting aesthetics with durability, vibrant colors, and an eco-friendly formula. Their water-based composition allows for easy application, breathability, and safe use in both indoor and outdoor spaces.



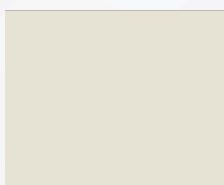

RAL 9002



RAL 9005

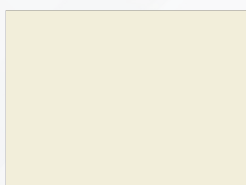

RAL 1013



RAL 6020

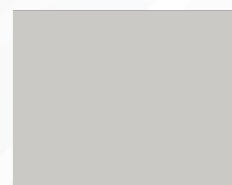

RAL 7035

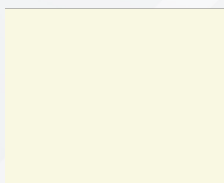

RAL 9010



RAL 8008



RAL 7046



RAL 7040

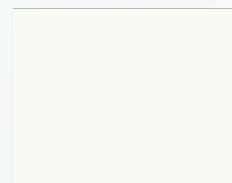

RAL 9016



RAL 5002



RAL 6005



RAL 1012



RAL 1024



RAL 5015



RAL 6002



RAL 6028



RAL 6033



RAL 7043



RAL 8004

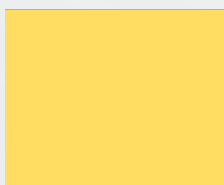

RAL 1018



RAL 2004



RAL 3020



RAL 1003



RAL 1028



RAL 2001



RAL 4002

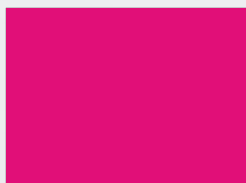

RAL 4010



RAL 6010

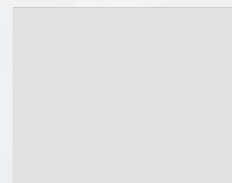

RAL 9006

The logo for DAYMIX GROUP features a stylized 'D' on the left, composed of a white semi-circle and a blue square with a yellow dot. To the right, the word 'DAYMIX' is written in white uppercase letters, and 'GROUP' is written in orange uppercase letters below it.

DAYMIX GROUP



Yenişehir Mahallesi Bakü Cad. Arma Residence
No:6 Kat:4 Daire:109 Pendik/İstanbul/Türkiye



+90 216 606 69 25



+90 501 142 81 25



info@daymixgroup.com



daymixgroup.com



daymixmuhendislik.com



daymixyapi.com



daymixkimya.com